

A4	mm	LENGTH	0.5-10	10-30	30-100	100-350	350-1000	RAD./CHAM	0.5-3	3-6	6-30	30-120	120-300	ANGLE	0.5-10	10-50	50-120	120-200
		TOLERANCE	±0.1	±0.2	±0.3	±0.5	±0.8	TOLERANCE	±0.2	±0.5	±1	±2	±4	TOLERANCE	±0.2	±0.5	±1	±2

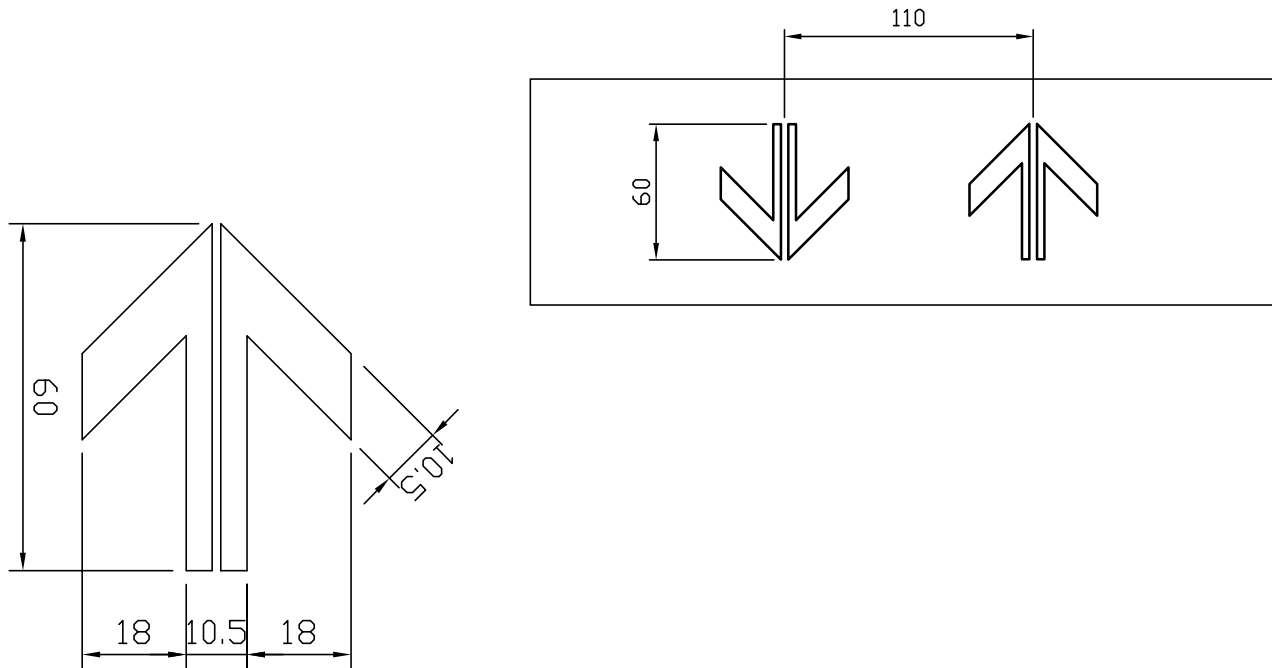

產品名稱	圖面	審核(APPROVE)	確認(CHECKED)	DATA	PAGE
抬頭到樓燈	CPI面板製作圖	LIN	YANG	2009/09/08	
產品編號	 通達機電有限公司 Tung Da Electric Co., Ltd	繪圖(DRWN)	圖號(DWG. NO)		
P-CPI-4C		CHUNG	P-CPI-X		